



Unboxing the Arqus

Magnus Berlander

Carl Stranne

Presenters



Magnus Berlander
CTO



Carl Stranne
Hardware team lead

GoToWebinar control panel

Show/hide control panel →

Full screen →

**Check your audio settings
if you can't hear us!**

Enter your questions here →

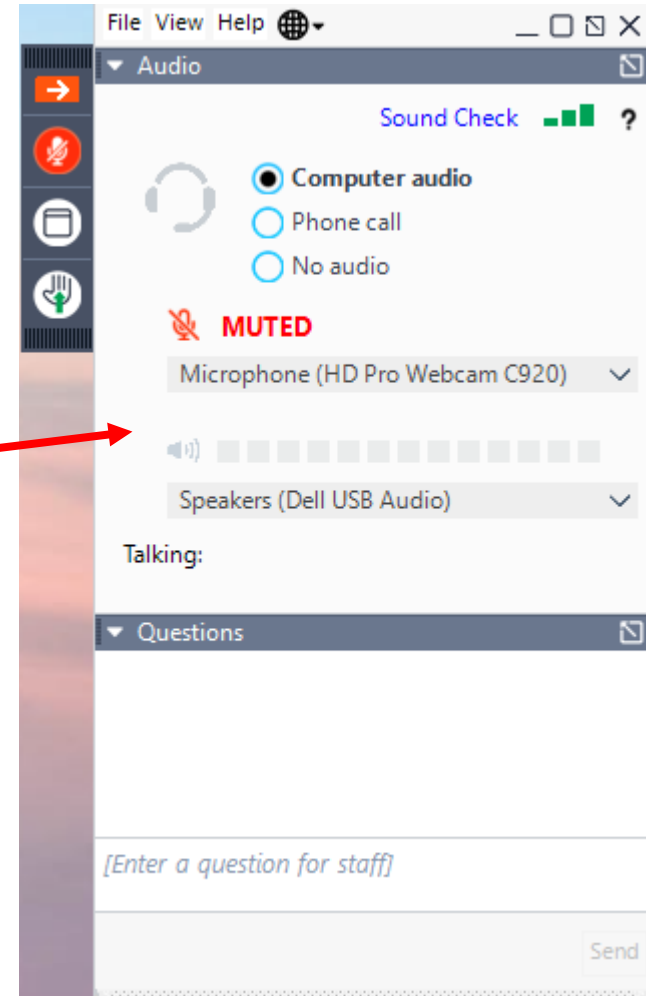



How many of you have used
Miquis or Oqus systems?

Please raise your hand now if you
have!

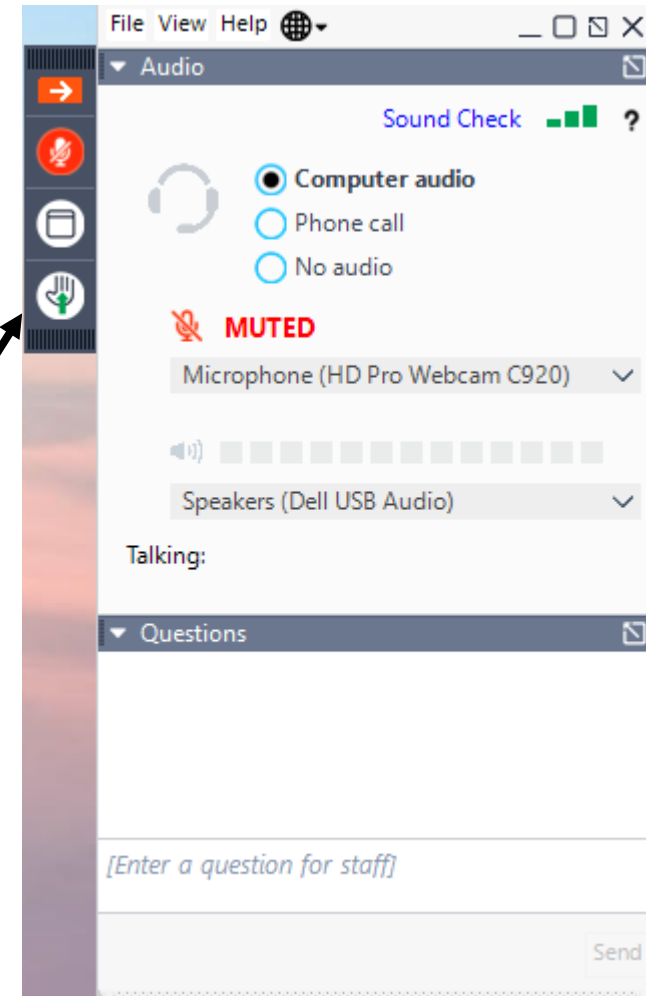







Overview of topics

- Unboxing and close look at the hardware (10 min)
- Arqus camera models overview (5 min)
- Arqus protected - All-weather properties (5 min)
- Choosing the right Qualisys camera (2 min)
- Q & A







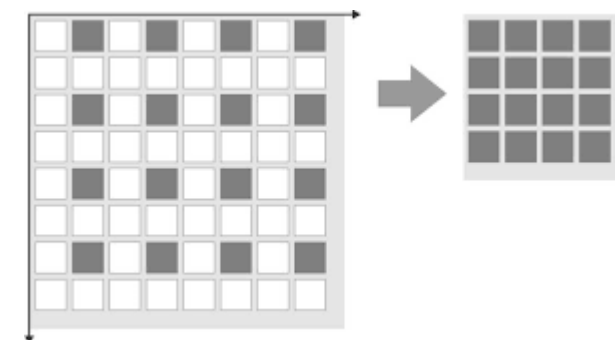

Models – comparison

	 Arqus A5	 Arqus A9	 Arqus A12	 Arqus A26	 Miqus M1	 Miqus M3	 Miqus M5
Normal mode (full FOV)	5 MP 700 fps	9 MP 290 fps	12 MP 300 fps	26 MP 150 fps	1 MP 250 fps	2 MP 340 fps	4 MP 180 fps



Options on optics

	 Arqus A5	 Arqus A9	 Arqus A12	 Arqus A26	 Miqus M1	 Miqus M3	 Miqus M5
Standard lens (FOV)	56 × 44 °	67 × 37 °	54 × 42 ° (motorized)	56 × 56 °	58 × 40 °	64 × 41 °	49 × 49 °
Wide lens (FOV)	77 × 62 °	82 × 48 °	70 × 56 °	77 × 77 °		80 × 53 °	
Narrow lens (FOV)	29 × 22 °	47 × 25 °	32 × 26 ° (motorized)	29 × 29 °	41 × 27 °	44 × 27 °	25 × 25 °

The unique cabling system

A single cable and connector combining Gigabit Ethernet and power in a daisy-chain

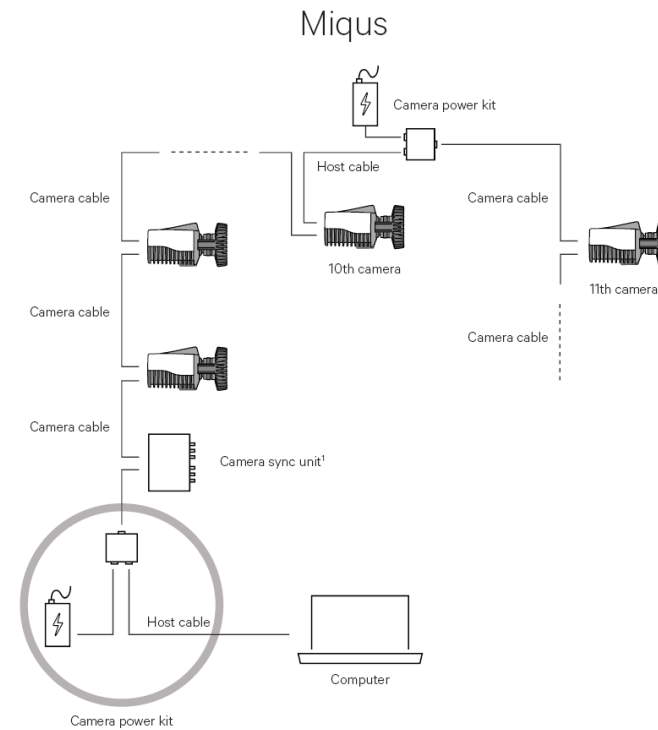
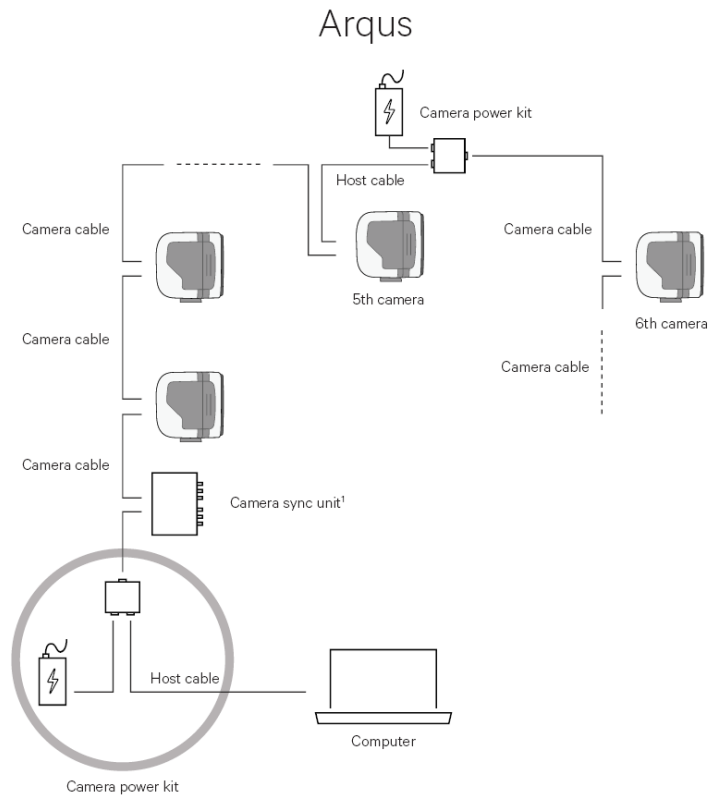

Choosing the right Qualisys camera

- Want to go outdoors in any weather? Rain, snow, dust?
 - Need the extended temperature range, -15°C to +45°C (5 – 113° F)?
 - Need industrial grade cabling?
-
- Need to measure on long distances or with really small markers?
Need to measure at very high frame rates?
-
- Need the highest number of cameras you can get without breaking the bank?
 - Need a small camera for tight spaces?
 - On a budget?

⇒ Go with
Arqus Protected



⇒ Go with
Arqus



⇒ Go with
Miqus



Availability

- Arqus will start shipping to customers in September
- Arqus is supported by QTM from version 2020.2 that was released June 29:th



Thank you!

Previous webinars <https://www.qualisys.com/webinars/>

Qacademy <https://www.qualisys.com/my/qacademy/#!/>

Thank you for joining us today!